

High Power 920 nm Fiber Based Femtosecond Laser (CFL)



Applications

- Multiphoton microscopy
- Harmonic generation imaging
- Optogenetics
- Fluorescence lifetime imaging
- Nonlinear spectroscopy
- Optical metrology
- Replacement of a Ti:sapphire laser

Features

- High power stability (up to 0.6 W)
- < 120 fs pulse widths
- Outstanding beam quality ($M^2 < 1.2$)
- Exceptional beam pointing stability
- Ultra-compact laser head
- All air-cooled, no chiller required
- Full computer control and data logging capability
- Remote system diagnostics

The Carmel X-series is a range of high power, air-cooled, fiber-based femtosecond lasers with output powers from 0.2 to greater than 2.5 W and pulse widths of less than 120 fs in the industry's most compact, user-friendly package. The Carmel X-920 is the latest member of the product family offering over 600 mW of output power at 920 nm, an ideal wavelength for multiphoton imaging of green fluorescent protein (GFP) variants.

The system features a rack mountable controller with a robust armored cable interface to the compact laser head, which facilitates its incorporation into OEM designs. It is over 100 times smaller than many Ti:sapphire lasers with a similar output power level. A simple key switch interface provides for manual operation with full remote access through computer control. The X-series includes the capability of remote data logging, power monitoring, system diagnostics, and automated adjustment of the second harmonic crystal for prolonged lifetime and OEM service support. The rugged design supports 24/7 operation with an expected lifetime of > 10,000 hours.

The Carmel X-920 can be specified with a repetition rate from 10 to 80 MHz and provides a clean pulse width of < 120 fs with minimal pulse pedestal. The system offers outstanding beam quality ($M^2 < 1.2$) and excellent long term pulse-to-pulse stability (<1% rms) over a wide operating temperature range (17-30°C) to ensure superior results for tissue imaging applications. An RF synchronization output is also provided as a trigger signal.

For multiphoton microscopy applications, the Carmel X-920 is an ideal excitation source for enhanced GFP imaging using mutated proteins that exhibit up to two orders of magnitude higher fluorescence signals. The compact laser head and associated armored fiber cable make for straight forward integration into existing microscopes with minimal delivery optics.

FIBER BASED FEMTOSECOND LASER

Technical Specifications¹

Model Number	CFL-05TFF
OPTICAL	
Average Power (W)	0.6
Repetition Rate ² (MHz)	80
Central Wavelength (nm)	920
Minimum Pulse Width ³ (fs)	< 120
Spectra Width (nm)	10
Pulse Energy (nJ)	7.5
Beam Quality, M ²	< 1.2
Beam Diameter at Exit, 2 ω_0 (mm)	1.0 (typical)
Beam Roundness (%)	> 90
Polarization Extinction Ratio (dB)	> 18
Power Stability in Operating Temperature Range (% rms, 8 hours) ⁴	< 1
Termination / Output	Free space, collimated beam
ELECTRICAL	
Supply Voltage (VAC)	85 - 264 autoranging
Supply Frequency (Hz)	47 - 63 autoranging
Power Consumption (VA)	200
RF Synchronization Output (V)	0.5 with SMA connector
MECHANICAL	
Warm up time (min)	10 (typical)
Operating Temperature (°C)	17 - 30
Storage Temperature (°C)	0 - 50
Connection between Controller and Head ⁵	1 m fixed armored fiber cable
Laser Head Dimensions (cm)	14(w) x 18(d) x 3.5(h)
Laser Controller Dimensions (cm)	48(w) x 44(d) x 9.8(h); 19" 2U
Laser Head Weight (kg)	0.8 (typical)
Laser Controller Weight (kg)	13.6 (typical)
Cooling	Air-cooled by low noise fan
I/O CONTROL	
Communication Interface Type	RS232, Monitor Ports
Laser Status Indicators on Controller Front Panel	Electrical Power On/Off, Laser On and Operational, Emergency Stop



FIBER BASED FEMTOSECOND LASER

¹ Due to our continuous improvement philosophy, all product specifications are subject to change without prior notice. Please contact sales@calmarlaser.com for customized specifications.

² The repetition rate needs to be specified at the time of purchase. For other repetition rates, please contact sales@calmarlaser.com.

³ A sech^2 pulse shape (deconvolution factor of 0.65) is used to determine the pulse width from the second harmonic autocorrelation trace.

⁴ With a temperature control of $\pm 0.5^\circ\text{C}$.

⁵ Please contact sales@calmarlaser.com for other cable length options.

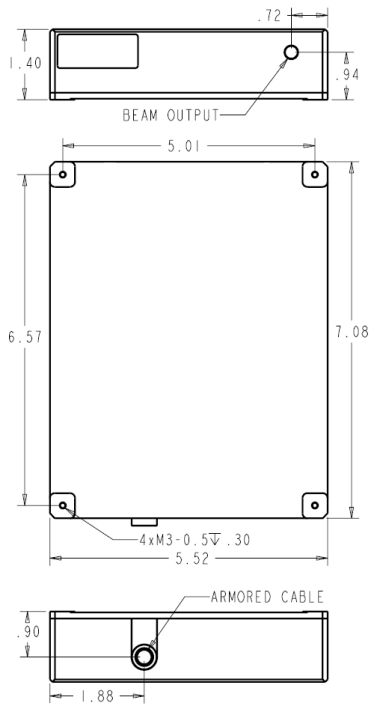

Dimensions of Laser Head
Unit: inch

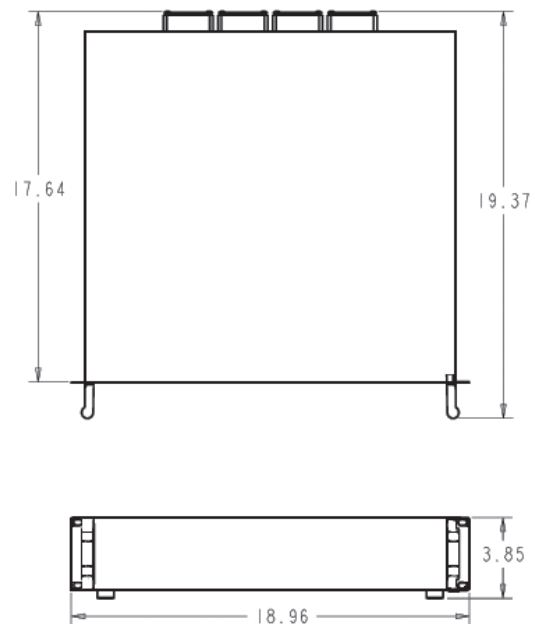

Dimensions of Laser Controller
Unit: inch

